

# ECLIPSE® TYPE 1 PICKING TROLLEY

## ASSEMBLY INSTRUCTIONS

1

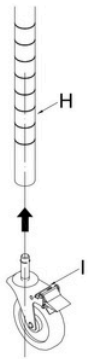

2

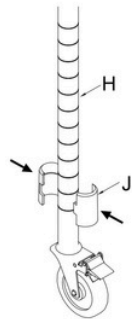

3

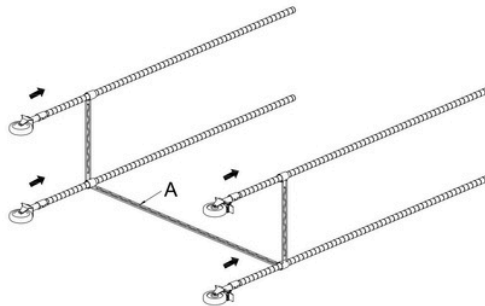

4

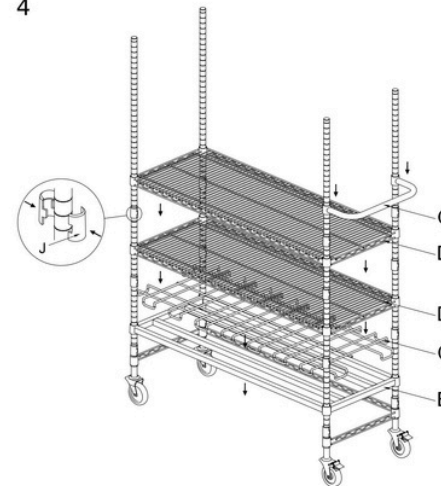

Press castor stems into bottoms of posts until fully engaged. Use a rubber mallet or hammer wrapped in a towel to tap casters firmly in place.

5

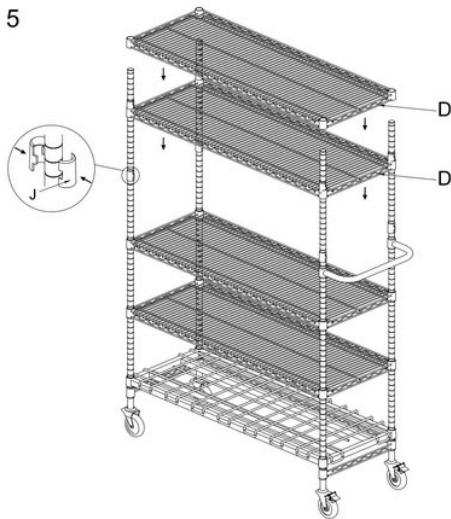

6

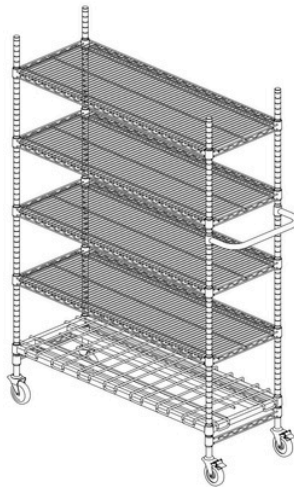



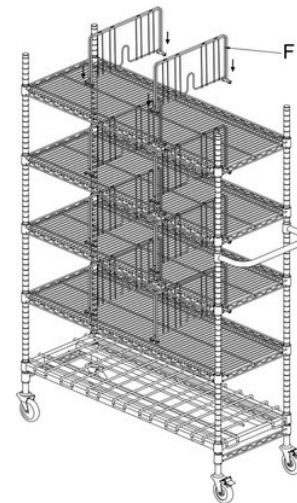



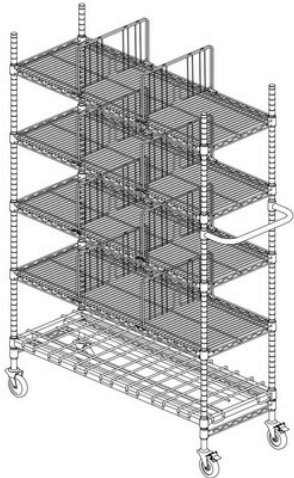
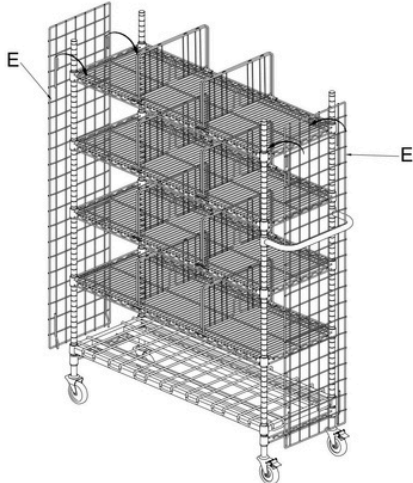
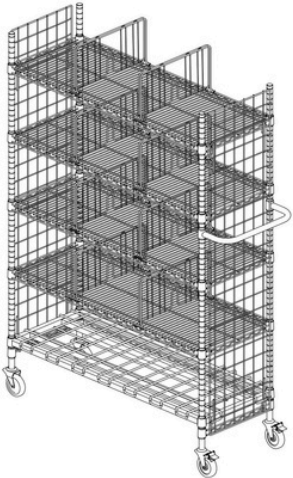

7

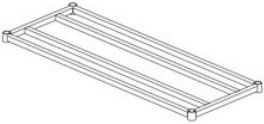
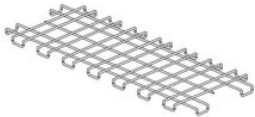
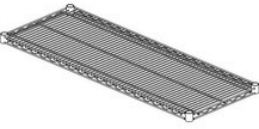

# ECLIPSE® TYPE 1 PICKING TROLLEY

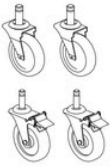
## ASSEMBLY INSTRUCTIONS

8		9		10	
					
A	B	C	D	E	
					
1PC	1PC	1PC	4PCS		
F	G	H	I	J	
					
8PCS	1PC	4PCS	2 WITH BRAKES 2 W/O BRAKES	52PCS (EXTRA 4PCS)	
				2PCS	

# ECLIPSE® TYPE 1 PICKING TROLLEY

Description	D x L x H (mm)	Product Code
5 tier with standard shelves and dividers	460 x 1220 x 1790	PT1848T1
4 tier with basket shelves	460 x 915 x 1790	PT1836T2
4 tier with top sloping shelf	460 x 1220 x 1790	PT1848T3
4 tier with 2 top sloping shelves	460 x 915 x 1790	PT1836T4

## VARIATIONS



**PT1848T1**

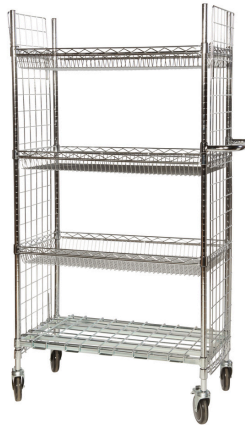

**PT1836T2**



**PT1848T3**



**PT1836T4**