

ECLIPSE® TYPE 3 PICKING TROLLEY

ASSEMBLY INSTRUCTIONS

1

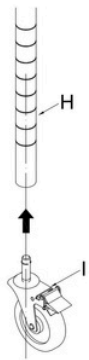

Press caster stems into bottoms of posts until fully engaged. Use a rubber mallet or hammer wrapped in a towel to tap casters firmly in place.

2

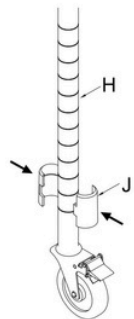

3

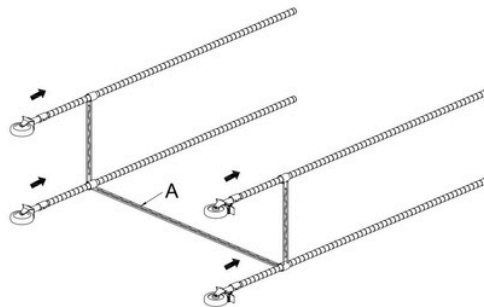

4

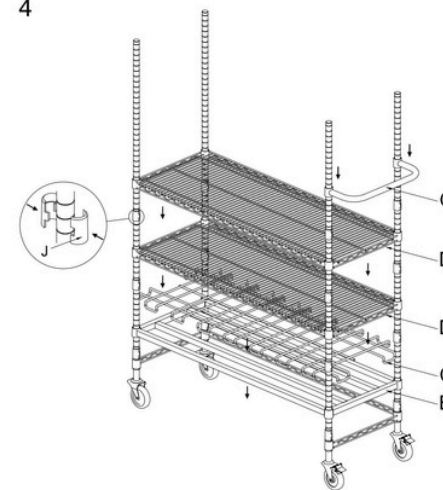

5

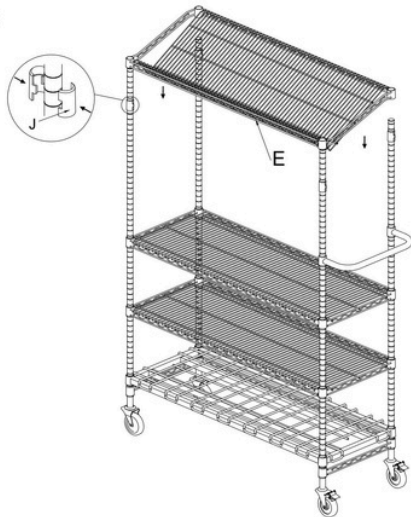

6

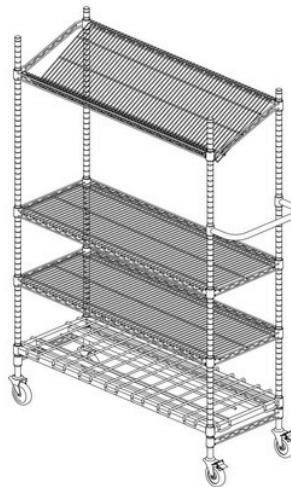



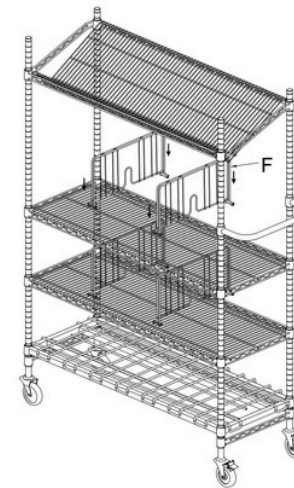





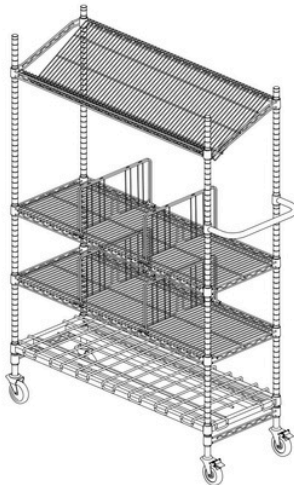
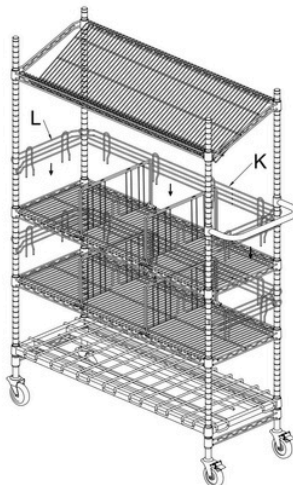
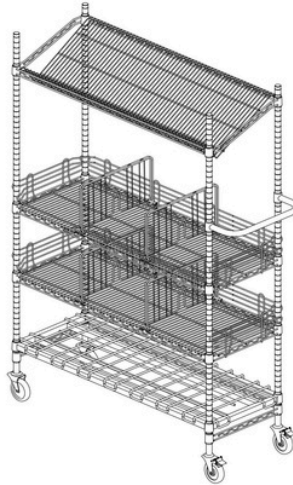

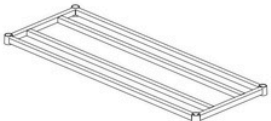
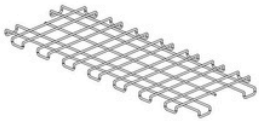
7

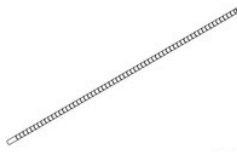
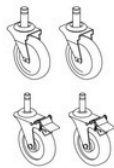

ECLIPSE® TYPE 3 PICKING TROLLEY

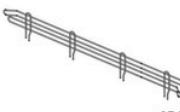
ASSEMBLY INSTRUCTIONS

<p>8</p> 	<p>9</p> 	<p>10</p> 			
<p>A</p>  <p>1PC</p>	<p>B</p>  <p>1PC</p>	<p>C</p>  <p>1PC</p>	<p>D</p>  <p>2PCS</p>	<p>E</p>  <p>1PC</p>	
<p>F</p>  <p>4PCS</p>	<p>G</p>  <p>1PC</p>	<p>H</p>  <p>4PCS</p>	<p>I</p>  <p>2 WITH BRAKES 2 W/O BRAKES</p>	<p>J</p>  <p>44PCS (EXTRA 4PCS)</p>	<p>K</p>  <p>2PCS</p> <p>L</p>  <p>4PCS</p>

ECLIPSE® TYPE 3 PICKING TROLLEY

Description	D x L x H (mm)	Product Code
5 tier with standard shelves and dividers	460 x 1220 x 1790	PT1848T1
4 tier with basket shelves	460 x 915 x 1790	PT1836T2
4 tier with top sloping shelf	460 x 1220 x 1790	PT1848T3
4 tier with 2 top sloping shelves	460 x 915 x 1790	PT1836T4

VARIATIONS



PT1848T1



PT1836T2



PT1848T3



PT1836T4